

SPECIFICATIONS MICRO-MINI DUAL KEY AC RECEPTACLES (2-6 POLE)

- Male and Female Receptacles
- 22 AWG
- 300V 105°C
- Hardware Options Below
- Meets Current SAE #H1738-2 Specifications



TECHNICAL DATA

Agency Approvals

UL Recognition:

File #E169897

CSA Certification:

File #LR13963

Electrical Data

Contact Resistance:

≤ 5mΩ

Current Rating:

See chart with part number detail

Voltage Rating:

300 VAC

Dielectric Withstand Voltage:

1600 VAC

Environmental Data

Protection:

NEMA 1, 3, 4, 6P and 13; IEC IP 68

Temperature Range:

-20° to +105°C

Material Data

Insert:

Black, Nylon 6/6

Pigtail Leads:

AWM/MTW UL style 1430 or 1569

Contacts:

Machined Brass

Contact Plating:

30 micro-inches of 24 karat Gold over 50 micro-inches of Nickel

Receptacle Shell:

Machined Aluminum with anodize finish and clear sealant

Nylon 6/6 weather stabilized (except 1/2" — NPT design)

303 Stainless Steel



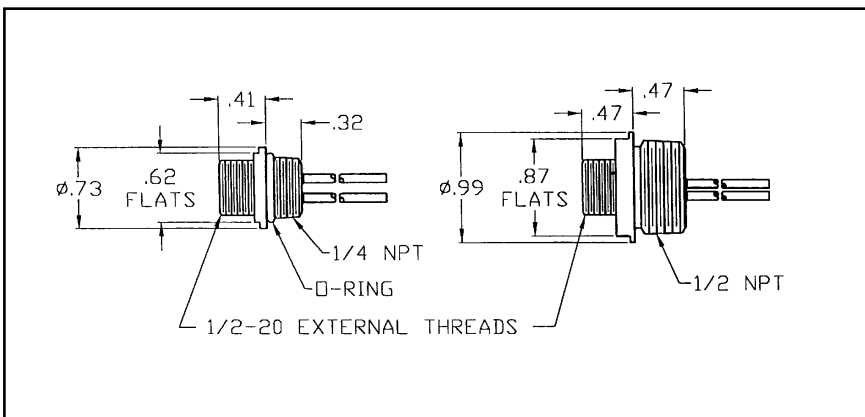

Potting Compound:

Black rigid epoxy





DIMENSIONS



MICRO-MINI DUAL KEY FEMALE RECEPTACLE WITH MACHINED ALUMINUM RECEPTACLE SHELL





POLES	FACE VIEW FEMALE	COLOR CODE	RATING	AWG	LEAD LENGTH	1/4"-NPT	1/2"-NPT
2		1. Brown 2. Blue	300V, 4A	22	3"	5000113-26	5000113-27
3		1. Green 2. Red-Black 3. Red-White	300V, 4A	22	3"	5000114-26	5000114-27
4		1. Red-Black 2. Red-White 3. Red 4. Green	300V, 4A	22	3"	5000115-26	5000115-27
5		1. Red-White 2. Red 3. Green 4. Red-Yellow 5. Red-Black	300V, 4A	22	3"	5000116-26	5000116-27

MICRO-MINI DUAL KEY MALE RECEPTACLE WITH MACHINED ALUMINUM RECEPTACLE SHELL





POLES	FACE VIEW MALE	COLOR CODE	RATING	AWG	LEAD LENGTH	1/4"-NPT	1/2"-NPT
2		1. Brown 2. Blue	300V, 4A	22	3"	5000113-1	5000113-14
3		1. Green 2. Red-Black 3. Red-White	300V, 4A	22	3"	5000114-1	5000114-14
4		1. Red-Black 2. Red-White 3. Red 4. Green	300V, 4A	22	3"	5000115-1	5000115-14
5		1. Red-White 2. Red 3. Green 4. Red-Yellow 5. Red-Black	300V, 4A	22	3"	5000116-1	5000116-14
6		1. Red-White 2. Red 3. Green 4. Red-Yellow 5. Red-Black 6. Red-Blue	300V, 3A	22	3"	5000127-1	5000127-14

Note: Special lead lengths available upon request — consult factory.

MICRO-MINI DUAL KEY FEMALE RECEPTACLE WITH *NYLON* RECEPTACLE SHELL





POLES	FACE VIEW FEMALE	COLOR CODE	RATING	AWG	LEAD LENGTH	1/4"-NPT
2		1. Brown 2. Blue	300V, 4A	22	3"	5000113-26N
3		1. Green 2. Red-Black 3. Red-White	300V, 4A	22	3"	5000114-26N
4		1. Red-Black 2. Red-White 3. Red 4. Green	300V, 4A	22	3"	5000115-26N
5		1. Red-White 2. Red 3. Green 4. Red-Yellow 5. Red-Black	300V, 4A	22	3"	5000116-26N

MICRO-MINI DUAL KEY MALE RECEPTACLE WITH *NYLON* RECEPTACLE SHELL





POLES	FACE VIEW MALE	COLOR CODE	RATING	AWG	LEAD LENGTH	1/4"-NPT
2		1. Brown 2. Blue	300V, 4A	22	3"	5000113-1N
3		1. Green 2. Red-Black 3. Red-White	300V, 4A	22	3"	5000114-1N
4		1. Red-Black 2. Red-White 3. Red 4. Green	300V, 4A	22	3"	5000115-1N
5		1. Red-White 2. Red 3. Green 4. Red-Yellow 5. Red-Black	300V, 4A	22	3"	5000116-1N
6		1. Red-White 2. Red 3. Green 4. Red-Yellow 5. Red-Black 6. Red-Blue	300V, 3A	22	3"	5000127-1N

Note: Special lead lengths available upon request — consult factory.

MICRO-MINI DUAL KEY FEMALE RECEPTACLE WITH STAINLESS STEEL RECEPTACLE SHELL

POLES	FACE VIEW FEMALE	COLOR CODE	RATING	AWG	LEAD LENGTH	1/4"-NPT	1/2"-NPT
2		1. Brown 2. Blue	300V, 4A	22	3"	5000113-26X	5000113-27X
3		1. Green 2. Red-Black 3. Red-White	300V, 4A	22	3"	5000114-26X	5000114-27X
4		1. Red-Black 2. Red-White 3. Red 4. Green	300V, 4A	22	3"	5000115-26X	5000115-27X
5		1. Red-White 2. Red 3. Green 4. Red-Yellow 5. Red-Black	300V, 4A	22	3"	5000116-26X	5000116-27X

MICRO-MINI DUAL KEY MALE RECEPTACLE WITH STAINLESS STEEL RECEPTACLE SHELL

POLES	FACE VIEW MALE	COLOR CODE	RATING	AWG	LEAD LENGTH	1/4"-NPT	1/2"-NPT
2		1. Brown 2. Blue	300V, 4A	22	3"	5000113-1X	5000113-14X
3		1. Green 2. Red-Black 3. Red-White	300V, 4A	22	3"	5000114-1X	5000114-14X
4		1. Red-Black 2. Red-White 3. Red 4. Green	300V, 4A	22	3"	5000115-1X	5000115-14X
5		1. Red-White 2. Red 3. Green 4. Red-Yellow 5. Red-Black	300V, 4A	22	3"	5000116-1X	5000116-14X
6		1. Red-White 2. Red 3. Green 4. Red-Yellow 5. Red-Black 6. Red-Blue	300V, 3A	22	3"	5000127-1X	5000127-14X

Note: Special lead lengths available upon request — consult factory.